



PB5000+

HDMI Over IP Broadcaster w/ RS-232 & IR Pass-Thru

Sender



Receiver

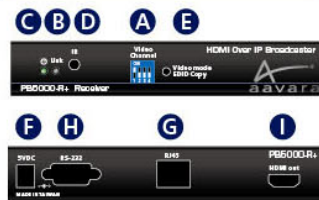

- A** Video Channel Selection
- B** Link LED Indicator
- C** Power LED Indicator
- D** Receiver: IR Receiver Jack
- E** Receiver: Video Mode/EDID Copy Button
 - Short Press: Video/Graphics Mode Switching
 - Long Press: Display EDID copy to Sender (Refer to Detail instruction at Display EDID Copy Section)
- F** Power Adapter DC Input
- G** RJ-45 Network Connector
- H** RS-232 Connector
- I** Sender: HDMI Input from Video Source
Receiver: HDMI Output to Display/TV/Projector
- J** Sender: IR Emitter Jack

* for more information, please visit Aavara.com

Specification

HDMI Video Resolution	480p, 576p, 720p, 1080p
PC DVI Resolution	Up to 1920x1200@60Hz
Receiver - HDMI Audio Output	Stereo, 16bits, 48KHz
HDMI Specification	v1.3 Compatible
DVI Specification	v1.0 Compliant
HDCP Specification	HDCP 1.1 / 1.2
Distance	Point to Point 100M Unlimited within LAN
RS-232 Baudrate	300~230,400bps Default 115,200bps
IR Control Pass Thru*	20~60KHz, To Use Infra Red Remote Control of Video Source Equipment (connected to Sender) to Control from Receiver side
Power Adapter	DC 5V
Power Consumption	5W
Dimensions	165 x 116 x 28mm (L x W x H)
Weight	325g
Optional Accessory	Wall Mount kit



1 to Many Displays

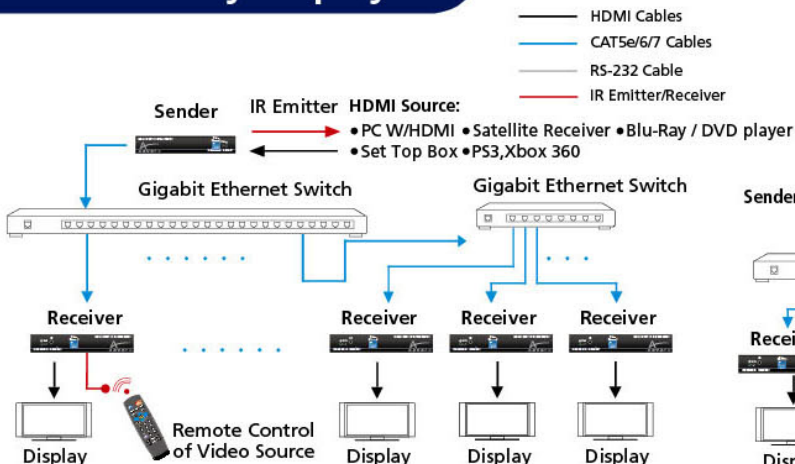

Multi-Casting

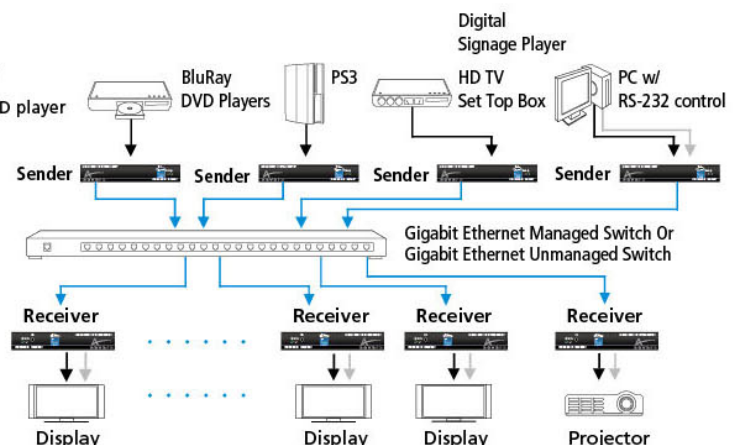

Broadcasting & MultiCasting Installation

- 1 Make sure all PB5000 Senders and PB5000 Receivers have Correct Video Channel setting.

1 to 1	All Same
1 to Many	All Same
Multicasting w/ VLAN by Layer 2 switch	All Same
Video Channel Matching	Refer to Example below

- 2 Connect all sources to each Sender with HDMI cable.
- 3 Plug IR Emitter cable into IR Emitter port on PB5000 Sender for IR Pass Thru function. Place IR Emitter toward the IR receiving window of video source. Plug IR Receiver cable into IR Receiver port on PB5000 Receiver, place IR Receiver toward to IR Remote location.
- 4 Connect all displays to each Receiver with HDMI cable.
- 5 Connect all PB5000 Senders and Receivers to Gigabit Ethernet Switch with CAT-5e/a Cat5 Cable cables. If 1 to 1 extender, Connect Sender and Receiver with CAT-5e/6/7 cable to its RJ-45 directly.
- 6 Power On Displays and Receivers (Plug-in DC adapter).
- 7 Power On Video sources and Senders (Plug-in DC adapter).

MultiCasting with Layer 2 Managed Switch

- 1 Make Sure Same Video Channel setting on all PB5000 senders and PB5000 receivers.
- 2 Config Layer 2 Managed Switch with 802.1Q VLAN setting (RJ-45 Port base Virtual Network).

Only One Sender is allowed in Each VLAN Group.
Multiple Receivers Ok in Each VLAN Group.
- 3 Following Standard Installation procedure to connect all senders and receivers to Layer 2 managed switch.

Troubleshooting

Problem	Solution
No Signal (Link LED Off or Flashing)	<ul style="list-style-type: none"> • Make sure CAT5e/6/7 cables are well connected on PB5000 Sender, Receiver and/or Switch. In most of case, good quality CAT5e UTP cable will be good for LAN connection. • Check power indicator and make sure power adapter had been plugged into power wall socket and connect to all Senders and Receivers. • Make sure HDMI cables are well connected between Sender and Video Source Receiver and Display. • Make sure Video Channel settings are Correct Matching all Senders and Receivers • Make sure Managed Switch 802.1Q settings PB5000 Sender & Receiver at same VLAN group. • Always Power on Sender first, then Receiver for smooth handshaking.
No Signal (But Link LED is ON)	<ul style="list-style-type: none"> • Refer to Display EDID Copy instruction above to improve EDID compatibility. • If PC to DVI monitor, set your PC video output frequency at 60Hz.
IR Pass Thru not function	<ul style="list-style-type: none"> • Make sue IR emitter had been plug-in IR emitter jack of Sender Before Power On. • Make sure IR emitter had pointed to the IR receiver window of HDMI video source device • Make sure Remote control of video source device has been pointed at IR receiver of Receiver. • Don't toward IR Receiver to any fluorescent lamp/tube or light source, it may interfere IR transmission.

Video Channel Matching (Easy MultiCasting) with Unmanaged Gigabit Ethernet Switch

- 1 Setting up a unique Video Channel setting on each PB5000 Sender with video source. Make sure the setting on each sender won't be duplicated.
- 2 On Video Channel Setting, PB5000 Receivers' Video Channel selection always match that of the Senders with the video sources you want to display.
- 3 Following Standard Installation procedure to setup all senders and receivers to unmanaged switch.

Video Channel Matching Config Example

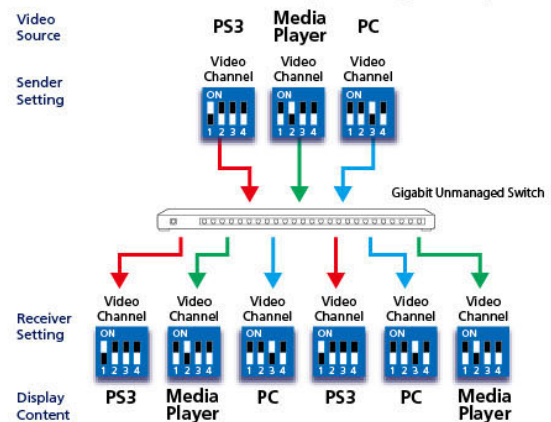

Notice: Number of Video Channel Senders will depend on video content, resolution and ethernet switch capacity.

Video Mode Switching (By Short Press of Receiver EDID button)

- Video mode(Auto) Smooth Motion, Auto switch between video mode and Grpahic mode depends on motion of video.
- Graphics mode Fixed at High Video Quality & Sharp Clear Detail, but High Bandwidth Required.



Display EDID Copy

1. Unplug Sender HDMI Connection while all other cables are connected (LINK LED On)
2. Long Press Receiver EDID button and hold it
3. Reboot Receiver (Unplug & Plug-in DC power) while keep press on Receiver EDID button
4. Release EDID button til Receiver Link LED start blinking
5. Reboot Sender and Plug-in Sender HDMI Connection

Video Wall Installtion (Y Screens Height, X Screens Width)

- Setting up Y pcs PB5000-S+ Sender Video Channel from 1 to Y without duplicating for each Row Video output.
- Setting up X pcs PB5000-R+ Receiver at same Video Channel as Sender for each Sender row.
- Connect all Senders, Receivers and a PC/NB to a Ethernet Gigabit switch. If managed switch used, made sure all units are in same VLAN group or just disable switch VLAN function.
- Using a HDMI Splitter to split same video source to all Senders.
- Launch Web browser, and browes URL:
http://ast-gateway0000.local
The first Sender's VideoWall configuration web page, Click on VideoWall Tab.
- Fill all basic setup requested info: how many screens at height and width, screen dimension/viewable dimension (at unit: 0.1mm) and click "Apply".
- Check "Show OSD", all displays will show OSD ID on screen, select Receiver (Show OSD number: IP Address) in pull down Apply List and assign correct Row/Column position to show correct image on videowall.

ie. 3x3 Video Wall Configuration

Sender Video Channel	Receiver Position, & Video Channel			
	Row \ Column	0	1	2
0000 	0	0,0 0000	0,1 0000	0,2 0000
1000 	1	1,0 1000	1,1 1000	1,2 1000
0100 	2	2,0 0100	2,1 0100	2,2 0100

* Video Channel Dip Switch swtting 0000 represent 4 dip switch, 0 is Off (Bottom Postion), 1 is On (Upper Position)

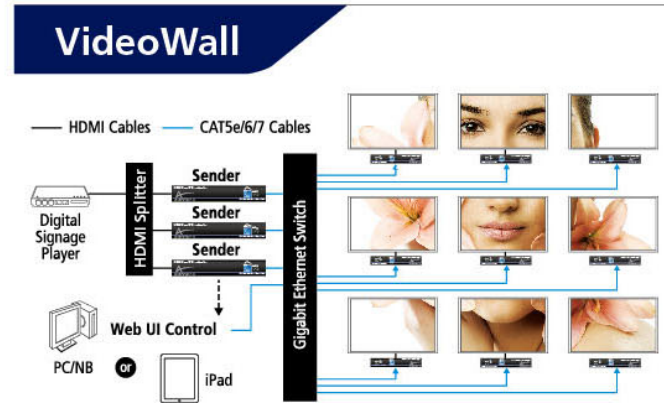

* Video Wall function need PB5000-S+ Sender & PB5000-R+ to co-work.

To Find PB5000 Senders and Receivers on Network

PB5000 is using mDNS (Multicast Domain Name System) for Sender and Receiver handshaking, which same as Bonjour service on Apple Mac OS X.

For finding and Linking Sender or Receiver by PC/NB with MS Windows OS, please download the Apple Bonjour SDK from following URL:

<https://developer.apple.com/bonjour/>

* Not needed in Apple Max Os X PC/NB, it's built-in in Mac OS X.

- Change PC/NB Ethernet RJ45 port IP setting to 169.254.100.200 or IP address within 169.254.???.??? C class. And, netmask 255.255.0.0
- To Link Sender or Receiver to Switch or to PC directly by Cat5e cable and Power On.
- May use third party's Bonjour Browser software to find all PB5000 Senders and Receivers on the Ethernet switch network.

PB5000 Host Name Rule

Sender ast-gateway0000.local
* 0000 represent video channel setting, 0 is Off, 1 is On

Receiver ast-client123456789012.local
* 123456789012 is Receiver's Mac Address

Launch Web browser to open the web page on PB5000 Sender or Receiver by IP or hostname.

** Google Chrome or Apple Safari recommended.

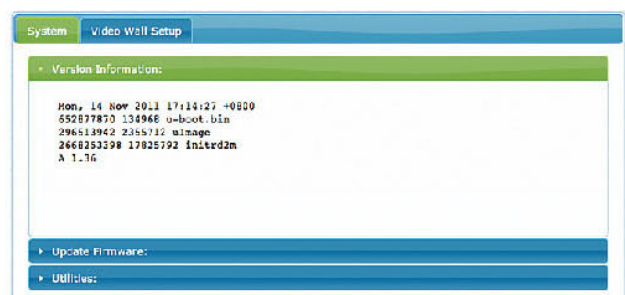
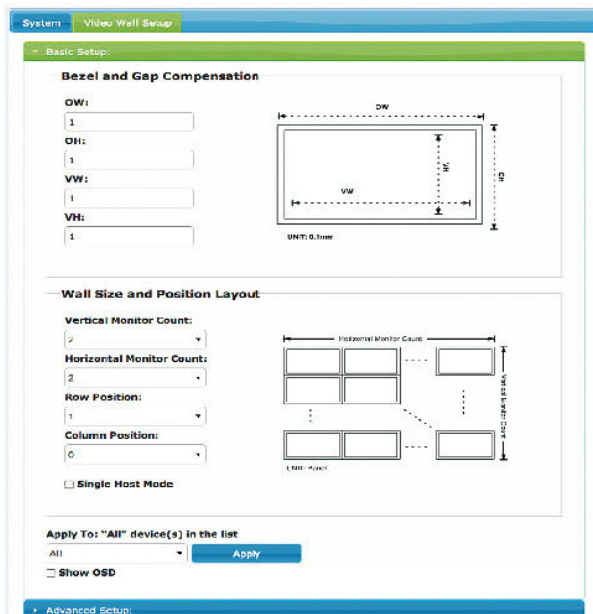

RS-232 Pass-Thru Installation

Customize RS-232 Baudrate Setting

RS-232 preconfigured baud rate setting (is 115200-8n1) It can be changed by following ways to match RS-232 Control Device or Display/TV/Projector:

By Telnet

- 1 Use a Telnet Client Link to PB5000+'s IP address at port 24.
ie. PB5000+ IP address is 169.254.6.211, then Telnet 169.254.6.211 24
- 2 Login name: "root", Password not needed.
- 3 Enter Command
astparam s s0_baudrate [Baudrate-8n1]
astparam save
reboot
ie. If Display's RS-232 baudrate is 9600 bps, then the first commend shall be:
astparam s s0_baudrate 9600-8n1
The unit will reboot automatically to take the new baudrate setting effect.

```
nick:~ mac$ telnet 169.254.6.211 24
Trying 169.254.6.211...
Connected to ast-gateway0000.local.
Escape character is '^]'.

ast-gateway0000 login: root
login: can't chdir to home directory '/root'

BusyBox v1.10.3 (2011-11-11 16:34:51 CST) built-in shell (ash)
Enter 'help' for a list of built-in commands.

/ # astparam s s0_baudrate 9600-8n1
/ # astparam save
/ # reboot
/ # Connection closed by foreign host.
```

By Web

- 1 Launch PB5000+ Web page by Web browser, Click "Utilities" Button.
- 2 In Console API field enter following commands, then click "Apply" Button.
astparam s s0_baudrate [Baudrate-8n1]; astparam save; reboot

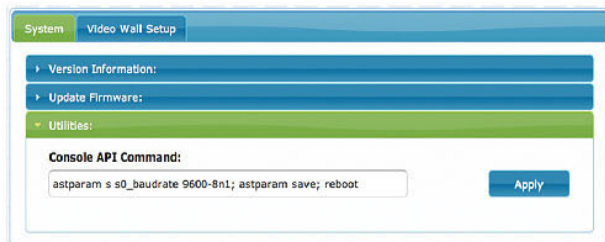

* Command is same as Telnet way, Shall be a ";" in between two commands to separate.

** Supported baudrate range: 300~230400 bps

Type 1 RS-232 Unicasting

1 Sender to 1 Receiver at Same Video Channel

PC/NB or RS232 Controller use 115200-8n1 (default, can be changed) to connect to PB5000-S+ Sender. Switch between "command mode" and "redirection mode" by sending "Ctrl+N" (0x0E) control code in RS-232 console.

- 1 Press "Ctrl+N" to Stop redirection mode, you will see a command prompt ">" shows up.
- 2 Enter following Unicast command in RS-232 Console as **ast_c [Receiver's Mac Address] [baudrate-8n1]**
ie. to connect to Receiver which has hostname ast-client0300000000F2.local & connected Display's RS-232 baudrate 9600bps:
"ast_c 0300000000F2 9600-8n1".
RS-232 Console will show:
====<Start of ast-client0300000000F2.local>====
Then, Unicasting mode start to that Receiver.

Type 2 RS-232 Broadcasting (Factory Default)

1 Sender to All Receivers at Same Video Channel

Under this mode, the RS232 redirection is automatically established between Sender and Receivers. Pre-configured baud rate setting is 115200-8n1(default, can be changed). Sender will Keep talking to all Receivers connected in same network or same VLAN group and same Video Channel. Once one of Receivers starting RS-232 communication, other Receivers won't be able to send data at same time. When that Receiver finishes RS-232 communication, Sender will keep waiting for a period of time without any data input then reopen RS-232 talking to other Receivers. The waiting period of time can be customized by following commands, default value is 1 second.

```
astparam s soip_type2_token_timeout [wait of sec.]
astparam save
reboot
```

Switch RS-232 mode between Unicasting and Broadcasting

- 1 Using Telnet or Web interface way to Link to PB5000-S+ Sender.
- 2 Enter following RS-232 mode change command as
astparam s soip_type2 y Broadcasting mode
or
astparam s soip_type2 n Unicasting mode
then
astparam save
reboot
After unit reboot, the new RS-232 mode change will take effect.